

PODSTAVKI

Opis in navodila za montažo

Podstavki so izdelani iz samougasnega trdega polikarbonata. Zaradi skeletne konstrukcije podstavka, ki je zvarjena iz Fe profilov in hladno cinkana, je podstavek zelo trden.

Pri izkopu je potrebno za pravilno postavitev podstavka upoštevati minimalno razdaljo od tal do omarice, ki je 500mm. Podstavek je potrebno postaviti na betonsko podlago in ga pritrditi z dvema sidrnima vijakoma skozi izvrtine na dnu podstavka. Podstavek se vkoplje do globine, ki je označena na podstavku.

Pri montaži je potrebno izvesti ozemljitev podstavka, pri čemer privijamo ozemljitveno žico s kabelskim čveljčkom na enega od vijakov, ki je pritrjen na okvir podstavka in na PEN zbiralko v omarici.

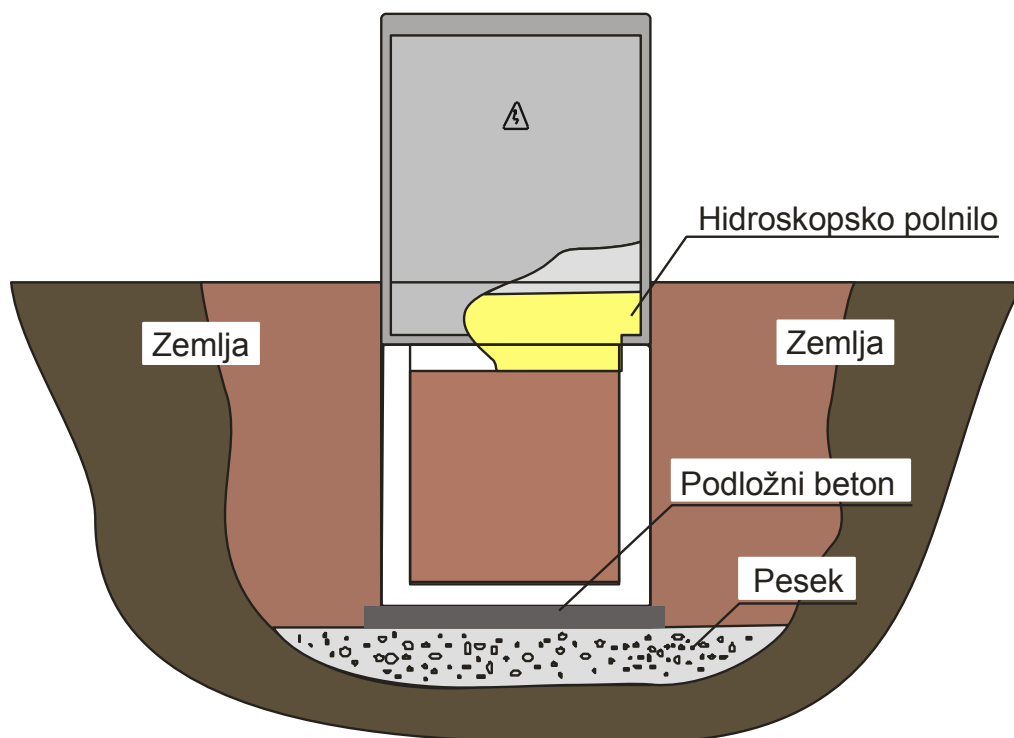

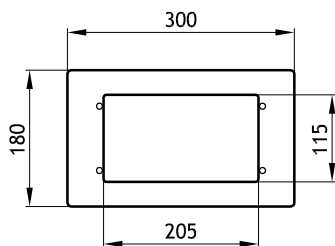
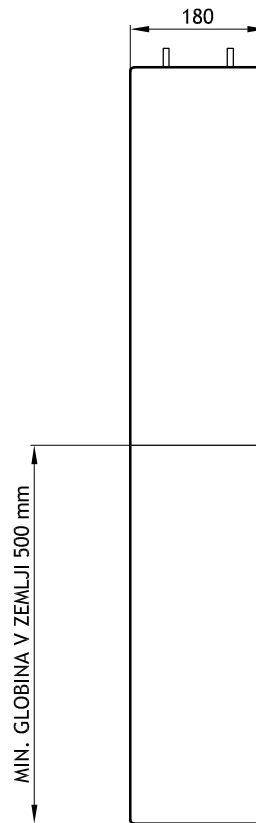
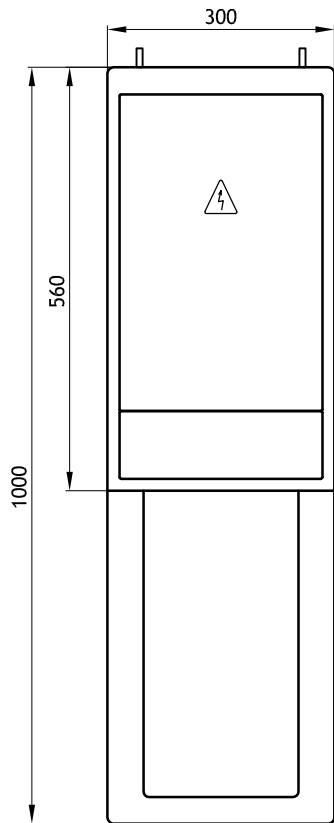

Izdelal:	Gregor PREBIL
Potrdil:	Matjaž PREBIL
EAN koda:	3831105204270
ID risbe:	05_001_4270.dwg
Datum:	03.2013

Vsebina:	PODSTAVEK 300
----------	---------------

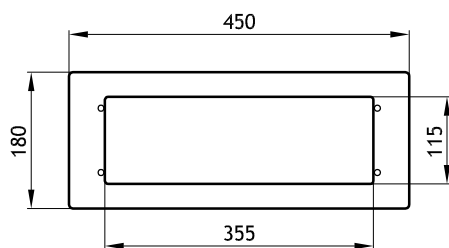
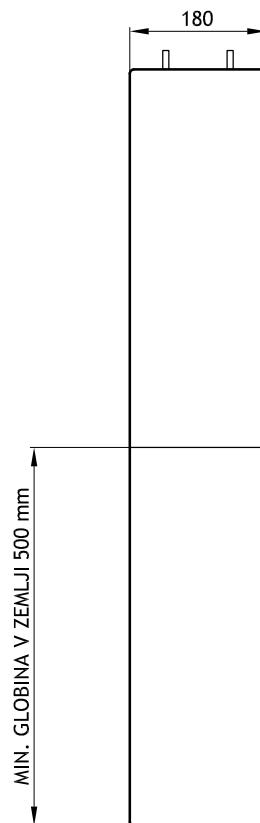
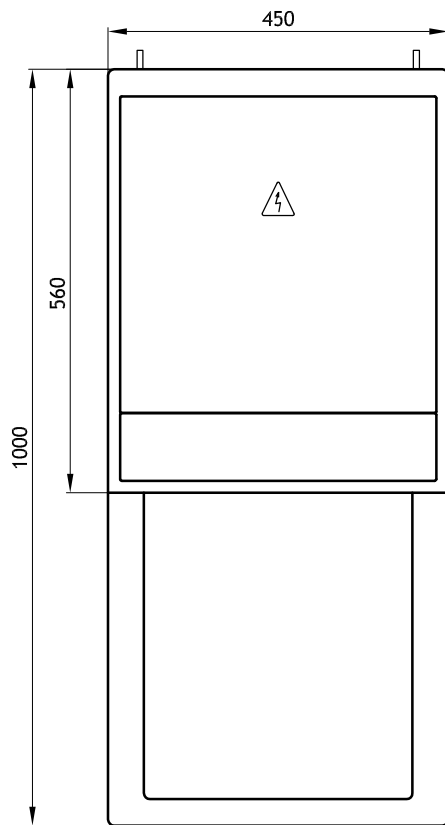

Izdelal:	Gregor PREBIL
Potrdil:	Matjaž PREBIL
EAN koda:	3831105203501
ID risbe:	05_002_3501.dwg
Datum:	03.2013

Vsebina:	PODSTAVEK 450
----------	---------------

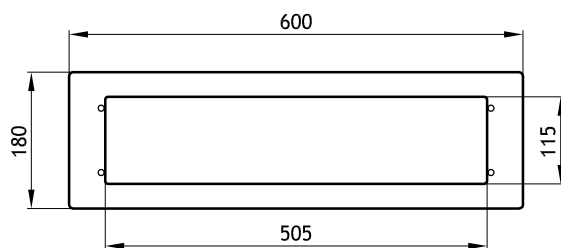
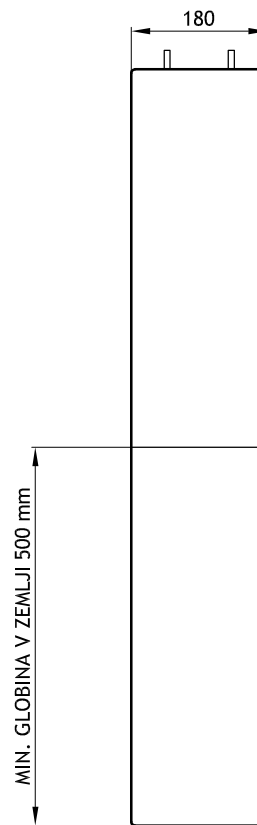
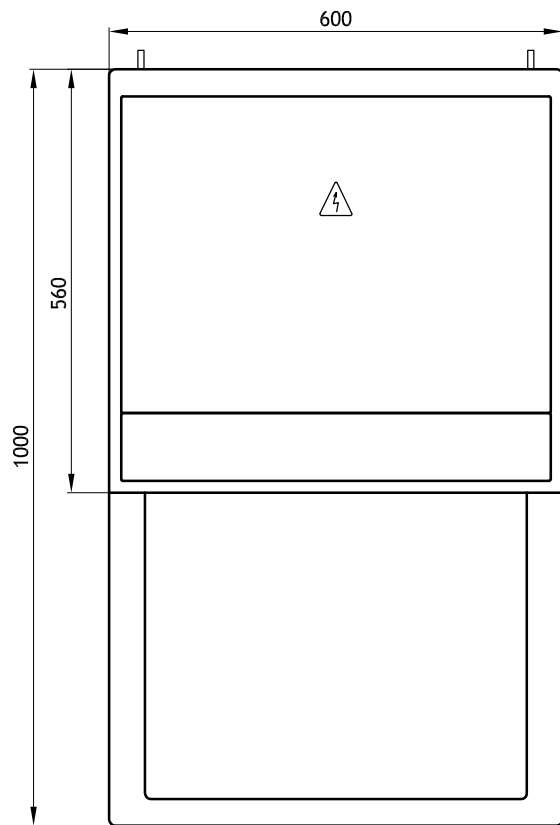

Izdelal:	Gregor PREBIL
Potrdil:	Matjaž PREBIL
EAN koda:	3831105203556
ID risbe:	05_003_3556.dwg
Datum:	03.2013

Vsebina:	PODSTAVEK 600		
Merilo:	1:10	List/listov:	1/1

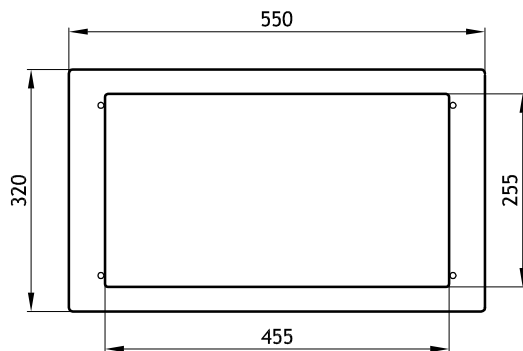
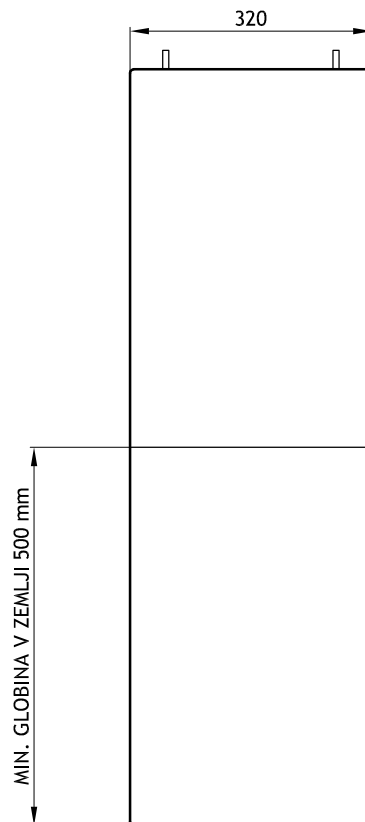
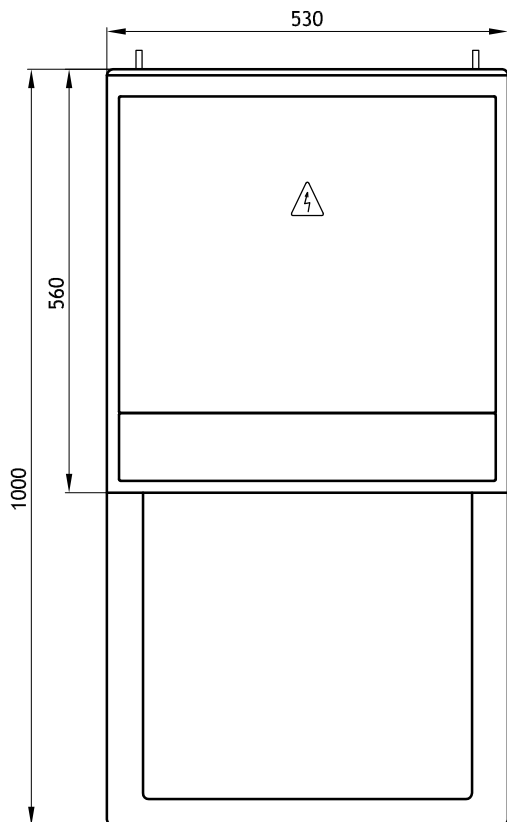

Izdelal:	Gregor PREBIL
Potrdil:	Matjaž PREBIL
EAN koda:	3831105201842
ID risbe:	05_004_1842.dwg
Datum:	03.2013

Vsebina:

PODSTAVEK
PS 5 NT

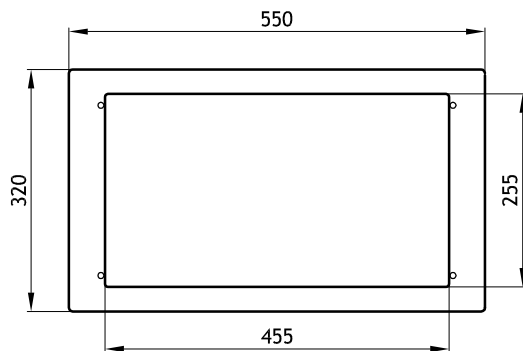
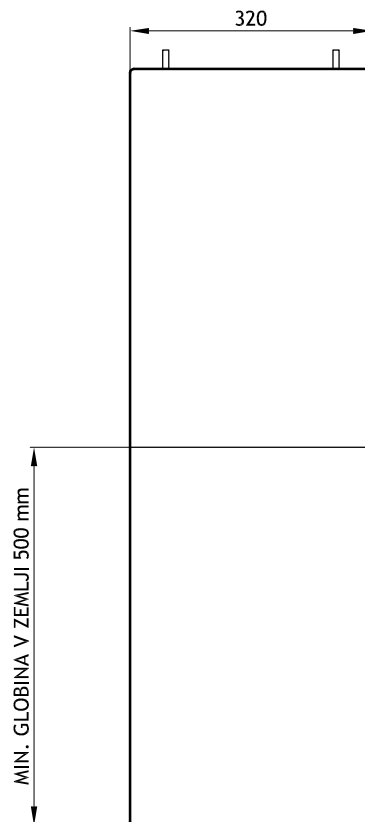
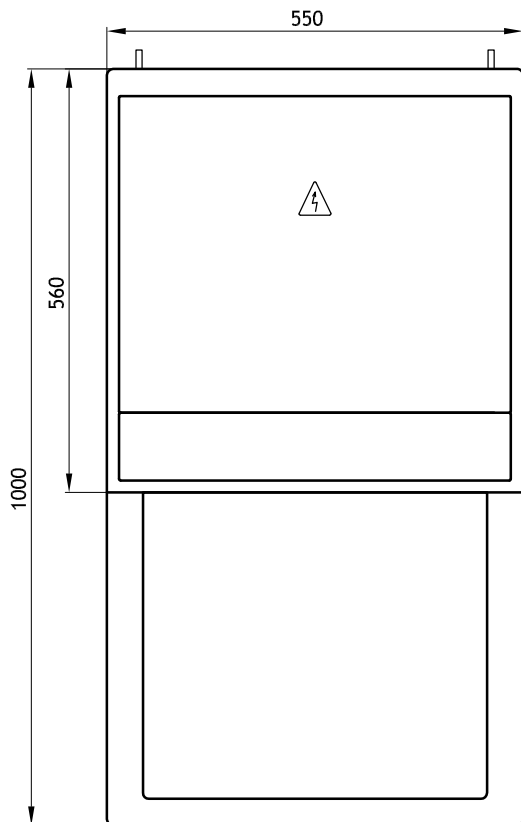

Izdelal:	Gregor PREBIL
Potrdil:	Matjaž PREBIL
EAN koda:	3831105204065
ID risbe:	05_005_4065.dwg
Datum:	03.2013

Vsebina:

PODSTAVEK
PS 3 NT

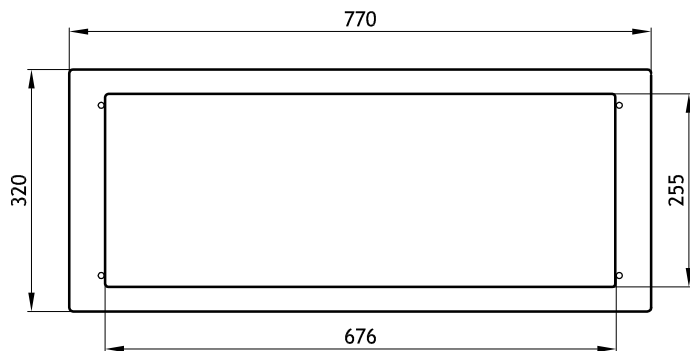
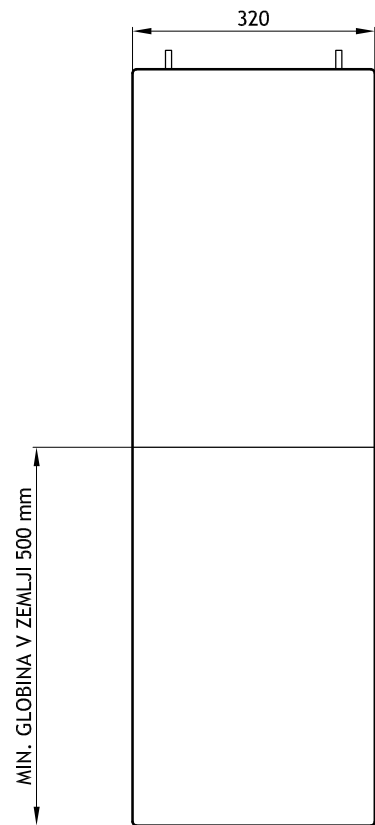
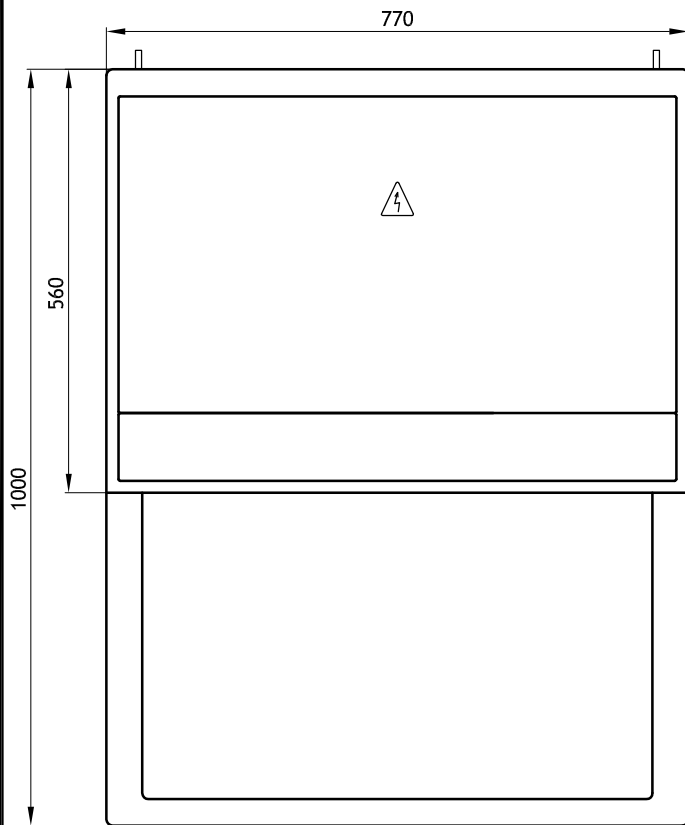

Izdelal:	Gregor PREBIL
Potrdil:	Matjaž PREBIL
EAN koda:	3831105201835
ID risbe:	05_006_1835.dwg
Datum:	03.2013

Vsebina:	PODSTAVEK PS 4 NT
Merilo:	1:10
List/listov:	1/1